

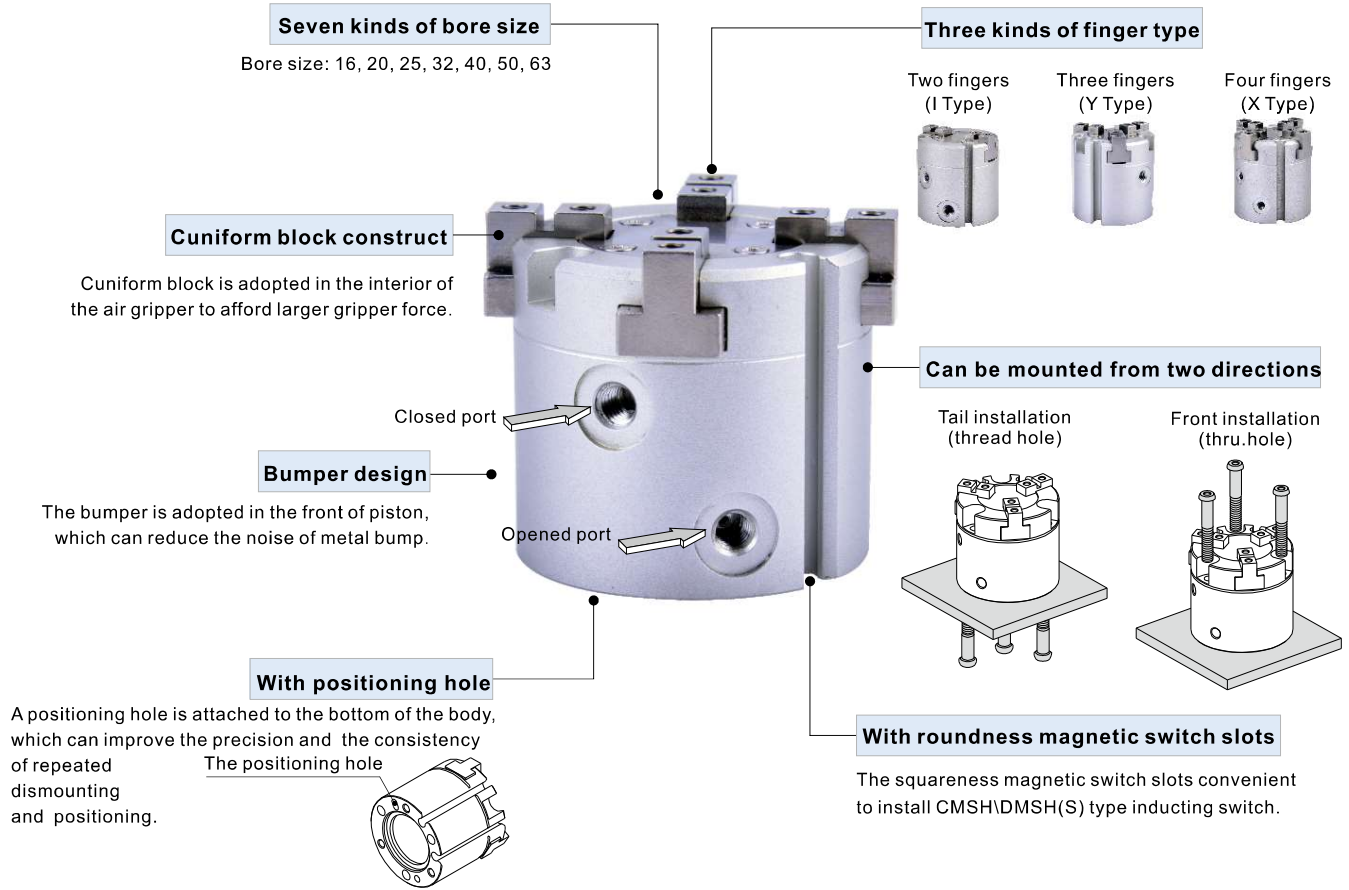

# Air gripper—HFC Series

Parallel open/close style

## Compendium of HFC Series



## Gripping force and stroke

Model	Gripping force per finger Effective valve(N)		Opening/Closing stroke (Both sides)(mm)	
	Internal	External		
2 grippers	HFCI16	23	21	4
	HFCI20	42	37	4
	HFCI25	71	63	6
	HFCI32	123	111	8
	HFCI40	195	177	8
	HFCI50	306	280	12
	HFCI63	537	502	16
3 grippers	HFCY16	16	14	4
	HFCY20	28	25	4
	HFCY25	47	42	6
	HFCY32	82	74	8
	HFCY40	130	118	8
	HFCY50	204	187	12
	HFCY63	359	335	16
4 grippers	HFCX16	12	10	4
	HFCX20	21	19	4
	HFCX25	35	31	6
	HFCX32	61	55	8
	HFCX40	97	88	8
	HFCX50	153	140	12
	HFCX63	268	251	16

Note) The gripping force in the above table is in the working pressure of 0.5MPa, and with a gripping point of L=20mm(Φ16~Φ25) or L=30mm(Φ32~Φ63).

Add) Please refer to page 405 for the definition of "L".

## Installation and application



1. Dirty substances in the pipe must be eliminated before air gripper is connected with pipeline to prevent the entrance of impurities into the cylinder.
2. The medium used by cylinder shall be filtered to 40μm or below.
3. Anti-freezing measure shall be adopted under low temperature environment to prevent moisture freezing.
4. If the air gripper is dismantled and stored for a long time, pay attention to conduct anti-rust treatment to the surface. Anti-dust caps shall be added in air inlet and outlet ports.



# Air gripper(parallel open/close style)

## HFC Series



### Specification

Bore size (mm)	16	20	25	32	40	50	63
Acting type	Double acting						
Fluid	Air(to be filtered by 40μm filter element)						
Operating pressure	0.2~0.7MPa(28~100psi)(2.0~7.0bar)			0.15~0.7MPa(22~100psi)(1.5~7.0bar)			
Temperature	-10~60						
Lubrication	Not required						
Repeatability mm	±0.01						
Max. frequency	120(c.p.m)			60(c.p.m)			
Sensor switches	CMSH/DMSH(S) [Note]						
Port size	M3×0.5			M5×0.8			

[Note] Sensor switch should be ordered additionally,  
Refer to P451 for detail of sensor switch.

### Symbol

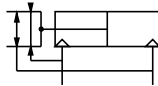

### Product feature

1. Cuniform block is adopted in the interior of the air gripper to afford larger gripper force.
2. The bumper is adopted in the front of piston, which can reduce the noise of metal bump.
3. A positioning hole is attached to the bottom of the body, which can improve the precision and the consistency of repeated dismounting and positioning.
4. Precision repeating snatch which adopted roboticized equipment.
5. Kinds of series and styles for you to choice which snatch multiform workpiece.

### Ordering code

#### HFC Y 20

① ② ③

① Model	② Finger type			③ Bore size
HFC: Air finger (Double acting, parallel type)	I: Two grippers	Y: Three grippers	X: Four grippers	16
				20
				25
				32
				40
				50
				63

Note: HFC series are all attached with magnet.

### Inner structure and material of major parts

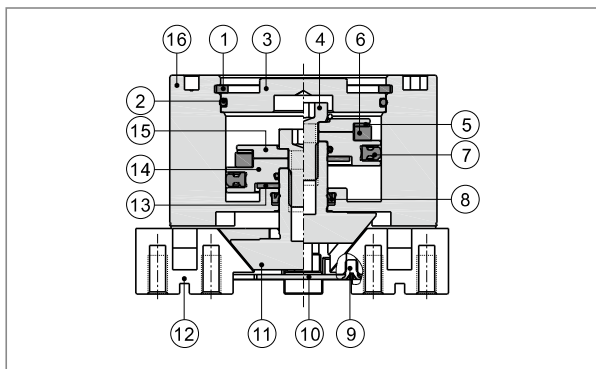

NO.	Item	Material
1	C clip	Spring steel
2	O-ring	NBR
3	Back cover	Aluminum alloy
4	Screw	Carbon steel
5	Magnet washer	NBR
6	Magnet	Sintered metal(Neodymium-iron-boron)
7	Piston seal	NBR
8	Rod packing	NBR
9	Countersink screw	Stainless steel
10	Cover blank	Stainless steel
11	Piston rod	Stainless steel
12	Gripper	Stainless steel
13	Bumper	TPU
14	Piston	Aluminum alloy
15	Magnet holder	Aluminum alloy
16	Body	Aluminum alloy

# Air gripper(parallel open/close style)



## HFC Series

### Dimensions

#### Two grippers

Φ16~Φ25

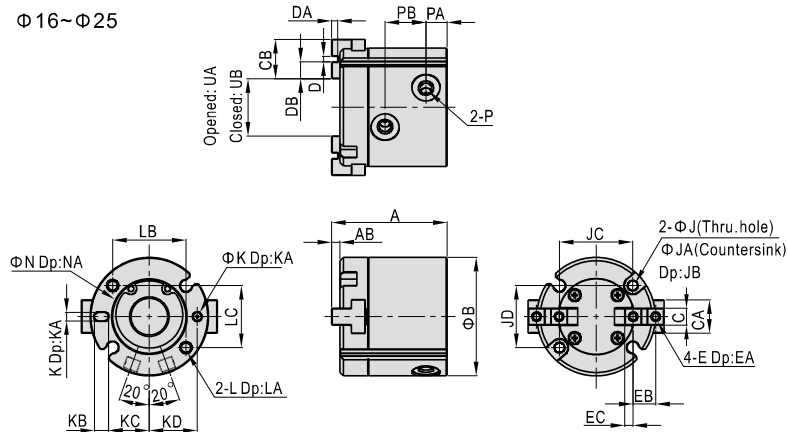

Model\Item	A	AB	B	C	CA	CB	D	DA	DB	E	EA
HFC116	35	3	30	5 <sup>-0.01</sup> <sub>-0.03</sub>	8	10	2 <sup>+0.04</sup> <sub>+0.01</sub>	2 <sup>+0.2</sup> <sub>0</sub>	4	M3×0.5	5
HFC120	39	3	36	6 <sup>-0.01</sup> <sub>-0.03</sub>	10	12	2 <sup>+0.04</sup> <sub>+0.01</sub>	2 <sup>+0.2</sup> <sub>0</sub>	5	M3×0.5	5
HFC125	41	3	42	6 <sup>-0.01</sup> <sub>-0.03</sub>	12	14	2 <sup>+0.04</sup> <sub>+0.01</sub>	2 <sup>+0.2</sup> <sub>0</sub>	6	M3×0.5	5

Model\Item	EB	EC	J	JA	JB	JC	JD	K	KA	KB	KC	KD
HFC116	6	2	3.4	6	6	18	16	2 <sup>+0.04</sup> <sub>+0.01</sub>	2	3	11	12.5
HFC120	7	2.5	3.4	6	6	24	18	2 <sup>+0.04</sup> <sub>+0.01</sub>	2	3	13	14.5
HFC125	8	3	3.4	6	6	26	22	3 <sup>+0.04</sup> <sub>+0.01</sub>	3	5	14.5	17

Model\Item	L	LA	LB	LC	N	NA	P	PA	PB	UA	UB
HFC116	M4×0.7	8	18	16	17 <sup>+0.05</sup> <sub>0</sub>	1.5	M3×0.5	7	10	14	10
HFC120	M4×0.7	8	24	18	21 <sup>+0.05</sup> <sub>0</sub>	1.5	M5×0.8	7	13	16	12
HFC125	M4×0.7	8	26	22	26 <sup>+0.05</sup> <sub>0</sub>	1.5	M5×0.8	7.5	14.5	20	14

Φ32~Φ63

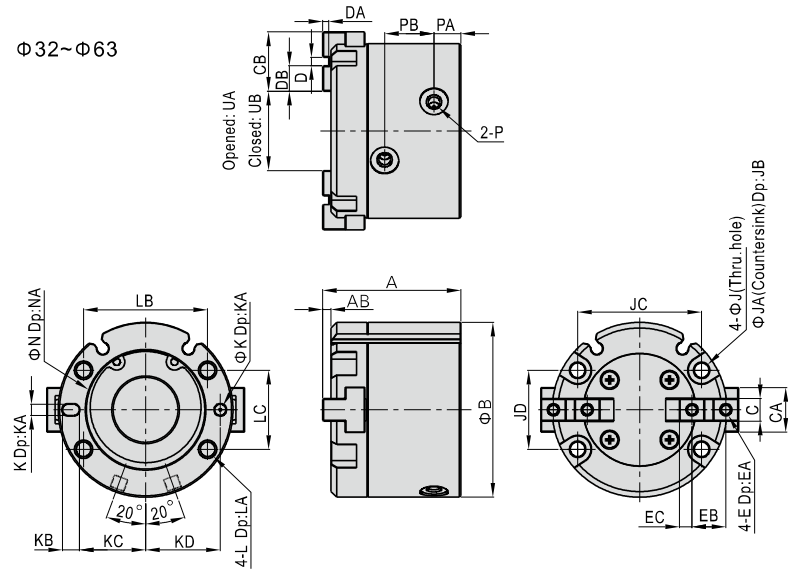

Model\Item	A	AB	B	C	CA	CB	D	DA	DB	E	EA
HFC132	45	3	55	8 <sup>-0.01</sup> <sub>-0.03</sub>	14	20	2 <sup>+0.04</sup> <sub>+0.01</sub>	2 <sup>+0.2</sup> <sub>0</sub>	9	M4×0.7	8
HFC140	49	3	62	8 <sup>-0.01</sup> <sub>-0.03</sub>	16	21	3 <sup>+0.04</sup> <sub>+0.01</sub>	2 <sup>+0.2</sup> <sub>0</sub>	9	M4×0.7	8
HFC150	57	3	70	10 <sup>-0.01</sup> <sub>-0.03</sub>	18	24	4 <sup>+0.04</sup> <sub>+0.01</sub>	2 <sup>+0.2</sup> <sub>0</sub>	10	M5×0.8	9
HFC163	68	4	86	12 <sup>-0.01</sup> <sub>-0.03</sub>	24	28	6 <sup>+0.04</sup> <sub>+0.01</sub>	3 <sup>+0.2</sup> <sub>0</sub>	11	M5×0.8	9

Model\Item	EB	EC	J	JA	JB	JC	JD	K	KA	KB	KC	KD
HFC132	11	4.5	4.2	8	9	38	25	3 <sup>+0.04</sup> <sub>+0.01</sub>	3	5	20.5	23
HFC140	12	4.5	5.2	9.5	9	44	28	4 <sup>+0.04</sup> <sub>+0.01</sub>	4	6	23.5	26.5
HFC150	14	5	5.2	9.5	12	52	34	4 <sup>+0.04</sup> <sub>+0.01</sub>	4	6	28	31
HFC163	17	5.5	5.2	9.5	14	66	38	5 <sup>+0.04</sup> <sub>+0.01</sub>	5	7	34.5	38

Model\Item	L	LA	LB	LC	N	NA	P	PA	PB	UA	UB
HFC132	M5×0.8	10	38	25	34 <sup>+0.05</sup> <sub>0</sub>	2	M5×0.8	8.5	16	24	16
HFC140	M6×1.0	12	44	28	42 <sup>+0.05</sup> <sub>0</sub>	2	M5×0.8	9.5	17.5	28	20
HFC150	M6×1.0	12	52	34	52 <sup>+0.05</sup> <sub>0</sub>	2	M5×0.8	9.5	21	34	22
HFC163	M6×1.0	12	66	38	65 <sup>+0.05</sup> <sub>0</sub>	2.5	M5×0.8	12	24	46	30

#### Three grippers

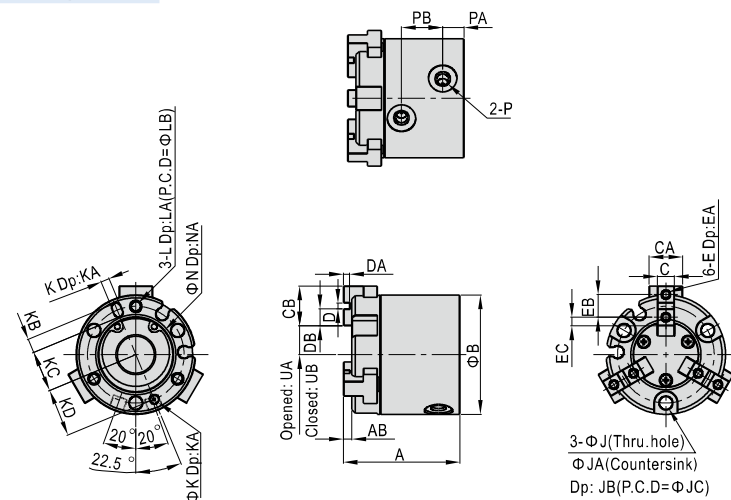

Model\Item	A	AB	B	C	CA	CB	D	DA	DB	E	EA
HFCY16	35	3	30	5 <sup>-0.01</sup> <sub>-0.03</sub>	8	10	2 <sup>+0.04</sup> <sub>+0.01</sub>	2 <sup>+0.2</sup> <sub>0</sub>	4	M3×0.5	5
HFCY20	39	3	36	6 <sup>-0.01</sup> <sub>-0.03</sub>	10	12	2 <sup>+0.04</sup> <sub>+0.01</sub>	2 <sup>+0.2</sup> <sub>0</sub>	5	M3×0.5	5
HFCY25	41	3	42	6 <sup>-0.01</sup> <sub>-0.03</sub>	12	14	2 <sup>+0.04</sup> <sub>+0.01</sub>	2 <sup>+0.2</sup> <sub>0</sub>	6	M3×0.5	5
HFCY32	45	3	52	8 <sup>-0.01</sup> <sub>-0.03</sub>	14	20	2 <sup>+0.04</sup> <sub>+0.01</sub>	2 <sup>+0.2</sup> <sub>0</sub>	9	M4×0.7	8
HFCY40	49	3	62	8 <sup>-0.01</sup> <sub>-0.03</sub>	16	21	3 <sup>+0.04</sup> <sub>+0.01</sub>	2 <sup>+0.2</sup> <sub>0</sub>	9	M4×0.7	8
HFCY50	57	3	70	10 <sup>-0.01</sup> <sub>-0.03</sub>	18	24	4 <sup>+0.04</sup> <sub>+0.01</sub>	2 <sup>+0.2</sup> <sub>0</sub>	10	M5×0.8	9
HFCY63	68	4	86	12 <sup>-0.01</sup> <sub>-0.03</sub>	24	28	6 <sup>+0.04</sup> <sub>+0.01</sub>	3 <sup>+0.2</sup> <sub>0</sub>	11	M5×0.8	9

Model\Item	EB	EC	J	JA	JB	JC	K	KA	KB	KC	KD	L
HFCY16	6	2	3.4	6	6	25	2 <sup>+0.04</sup> <sub>+0.01</sub>	2	3	11	12.5	M3×0.5
HFCY20	7	2.5	3.4	6	6	29	2 <sup>+0.04</sup> <sub>+0.01</sub>	2	3	13	14.5	M3×0.5
HFCY25	8	3	4.5	8	9	34	3 <sup>+0.04</sup> <sub>+0.01</sub>	3	5	14.5	17	M4×0.7
HFCY32	11	4.5	4.5	8	9	44	3 <sup>+0.04</sup> <sub>+0.01</sub>	3	5	19.5	22	M4×0.7
HFCY40	12	4.5	5.5	9.5	9	53	4 <sup>+0.04</sup> <sub>+0.01</sub>	4	6	23.5	26.5	M5×0.8
HFCY50	14	5	5.5	9.5	12	62	4 <sup>+0.04</sup> <sub>+0.01</sub>	4	6	28	31	M5×0.8
HFCY63	17	5.5	6.6	11	14	76	5 <sup>+0.04</sup> <sub>+0.01</sub>	5	7	34.5	38	M6×1.0

Model\Item	LA	LB	N	NA	P	PA	PB	UA	UB
HFCY16	6	25	17 <sup>+0.05</sup> <sub>0</sub>	1.5	M3×0.5	7	10	7	5
HFCY20	6	29	21 <sup>+0.05</sup> <sub>0</sub>	1.5	M5×0.8	7	13	8	6
HFCY25	8	34	26 <sup>+0.05</sup> <sub>0</sub>	1.5	M5×0.8	7.5	14.5	10	7
HFCY32	8	44	34 <sup>+0.05</sup> <sub>0</sub>	2	M5×0.8	8.5	16	12	8
HFCY40	10	53	42 <sup>+0.05</sup> <sub>0</sub>	2	M5×0.8	9.5	17.5	14	10
HFCY50	10	62	52 <sup>+0.05</sup> <sub>0</sub>	2	M5×0.8	9.5	21	17	11
HFCY63	12	76	65 <sup>+0.05</sup> <sub>0</sub>	2.5	M5×0.8	12	24	23	15



# Air gripper(parallel open/close style)



## HFC Series

### Four grippers

Φ16~Φ25

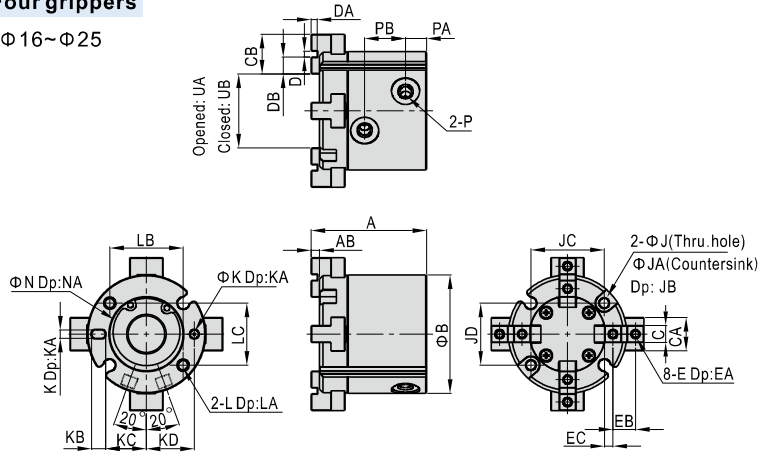

Model\Item	A	AB	B	C	CA	CB	D	DA	DB	E	EA
HFCX16	35	3	30	5 <sup>+0.01</sup> <sub>-0.03</sub>	8	10	2 <sup>+0.04</sup> <sub>+0.01</sub>	2 <sup>+0.2</sup> <sub>0</sub>	4	M3×0.5	5
HFCX20	39	3	36	6 <sup>+0.01</sup> <sub>-0.03</sub>	10	12	2 <sup>+0.04</sup> <sub>+0.01</sub>	2 <sup>+0.2</sup> <sub>0</sub>	5	M3×0.5	5
HFCX25	41	3	42	6 <sup>+0.01</sup> <sub>-0.03</sub>	12	14	2 <sup>+0.04</sup> <sub>+0.01</sub>	2 <sup>+0.2</sup> <sub>0</sub>	6	M3×0.5	5

Model\Item	EB	EC	J	JA	JB	JC	JD	K	KA	KB	KC	KD
HFCX16	6	2	3.4	6	6	18	16	2 <sup>+0.05</sup> <sub>0</sub>	2	3	11	12.5
HFCX20	7	2.5	3.4	6	6	24	18	2 <sup>+0.05</sup> <sub>0</sub>	2	3	13	14.5
HFCX25	8	3	3.4	6	6	26	22	3 <sup>+0.05</sup> <sub>0</sub>	3	5	14.5	17

Model\Item	L	LA	LB	LC	N	NA	P	PA	PB	UA	UB
HFCX16	M4×0.7	8	18	16	17 <sup>+0.05</sup> <sub>0</sub>	1.5	M3×0.5	7	10	17	13
HFCX20	M4×0.7	8	24	18	21 <sup>+0.05</sup> <sub>0</sub>	1.5	M5×0.8	7	13	19	15
HFCX25	M4×0.7	8	26	22	26 <sup>+0.05</sup> <sub>0</sub>	1.5	M5×0.8	7.5	14	26	20

Φ32~Φ63

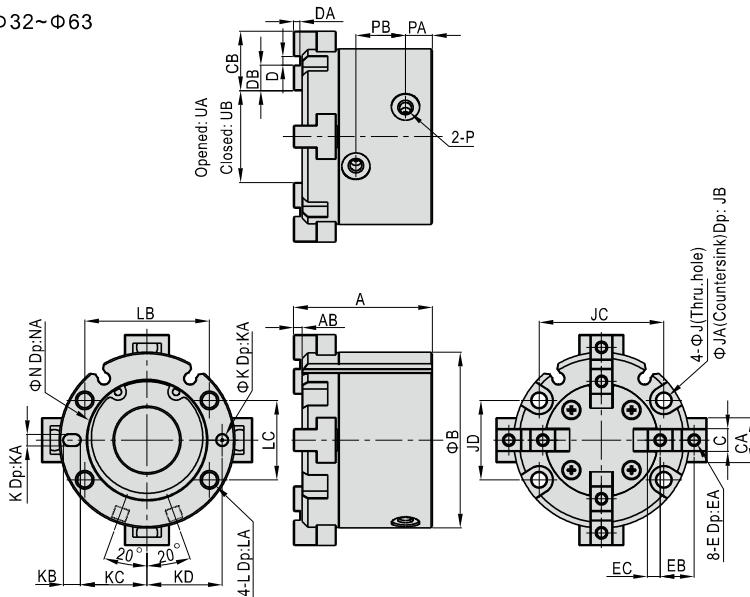

Model\Item	A	AB	B	C	CA	CB	D	DA	DB	E	EA
HFCX32	45	3	55	8 <sup>+0.01</sup> <sub>-0.03</sub>	14	20	2 <sup>+0.04</sup> <sub>+0.01</sub>	2 <sup>+0.2</sup> <sub>0</sub>	9	M4×0.7	8
HFCX40	49	3	62	8 <sup>+0.01</sup> <sub>-0.03</sub>	16	21	3 <sup>+0.04</sup> <sub>+0.01</sub>	2 <sup>+0.2</sup> <sub>0</sub>	9	M4×0.7	8
HFCX50	57	3	70	10 <sup>+0.01</sup> <sub>-0.03</sub>	18	24	4 <sup>+0.04</sup> <sub>+0.01</sub>	2 <sup>+0.2</sup> <sub>0</sub>	10	M5×0.8	9
HFCX63	68	4	86	12 <sup>+0.01</sup> <sub>-0.03</sub>	24	28	6 <sup>+0.04</sup> <sub>+0.01</sub>	3 <sup>+0.2</sup> <sub>0</sub>	11	M5×0.8	9

Model\Item	EB	EC	J	JA	JB	JC	JD	K	KA	KB	KC	KD
HFCX32	11	4.5	4.2	8	9	38	25	3 <sup>+0.04</sup> <sub>+0.01</sub>	3	5	20.5	23
HFCX40	12	4.5	5.2	9.5	9	44	28	4 <sup>+0.04</sup> <sub>+0.01</sub>	4	6	23.5	26.5
HFCX50	14	5	5.2	9.5	12	52	34	4 <sup>+0.04</sup> <sub>+0.01</sub>	4	6	28	31
HFCX63	17	5.5	5.2	9.5	14	66	38	5 <sup>+0.04</sup> <sub>+0.01</sub>	5	7	34.5	38

Model\Item	L	LA	LB	LC	N	NA	P	PA	PB	UA	UB
HFCX32	M5×0.8	10	38	25	34 <sup>+0.05</sup> <sub>0</sub>	2	M5×0.8	8.5	16	28	20
HFCX40	M6×1.0	12	44	28	42 <sup>+0.05</sup> <sub>0</sub>	2	M5×0.8	9.5	17.5	32	24
HFCX50	M6×1.0	12	52	34	52 <sup>+0.05</sup> <sub>0</sub>	2	M5×0.8	9.5	21	38	26
HFCX63	M6×1.0	12	66	38	65 <sup>+0.05</sup> <sub>0</sub>	2.5	M5×0.8	12	24	51	35

## How to select product

Please select pneumatic finger according to the following steps:

### ① The selection of the effective gripping force



### ② the confirmation of the gripping point

#### 1. The selection of the gripping force

The gripping work-pieces shown below, on the impact condition of ordinary handling state, taking safety coefficient a=4, have a gripping force that is more than 10-20 times of the mass of the gripped objects.

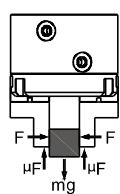

The work-pieces as shown in the left :

n: number of gripper  
 F: Gripping force (N)  
 μ: friction coefficient between fittings and work-pieces.  
 m: mass of work-pieces  
 g: acceleration of gravity (=9.8m/s<sup>2</sup>)

The condition that the work-pieces won't drop is:  $n \times \mu F > mg$

$$\text{so: } F > \frac{mg}{n \times \mu}$$

Safety coefficient is a, so F is:

$$F = \frac{mg}{n \times \mu} \times a$$

μ = 0.2

$$F = \frac{mg}{2 \times 0.2} \times 4 = 10 \times mg$$

10 times of the mass of the gripped objects

μ = 0.1

$$F = \frac{mg}{2 \times 0.1} \times 4 = 20 \times mg$$

20 times of the mass of the gripped objects

Note) If the friction coefficient μ > 0.2, for safety, please also select clamping force according to the principle of 10~20 times of the mass of the clamped objects. As for large acceleration and shock, it requires for greater safety coefficient.

1.1) The actual gripping force must be within the effective gripping forces of different pneumatic fingers specifications shown in the below chart.



# Air gripper(parallel open/close style)

## HFC Series

### Opened gripping force(I Type)

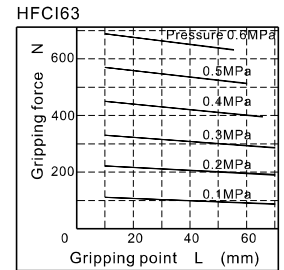
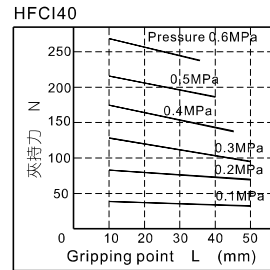
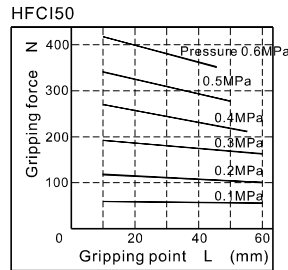
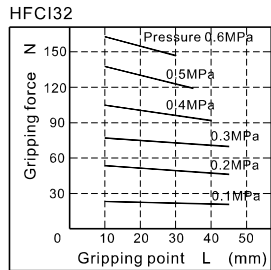
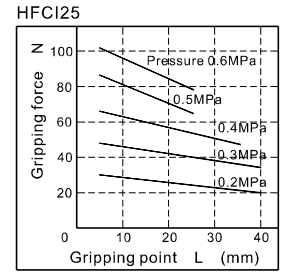
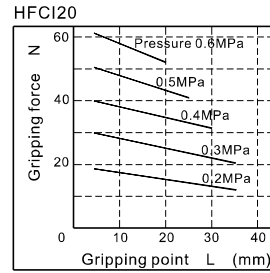
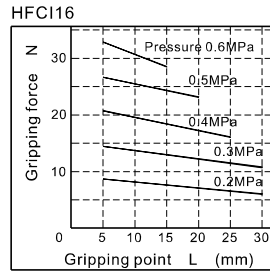
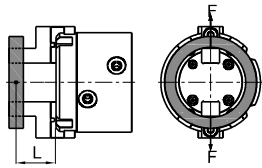

### Closed gripping force(I Type)

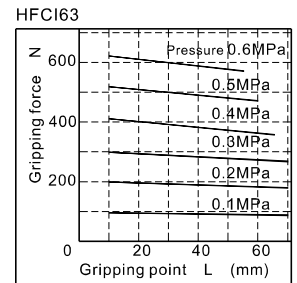
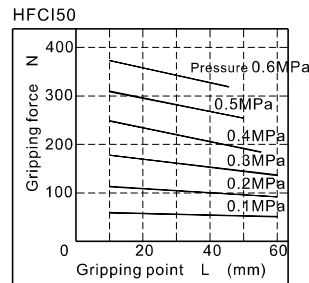
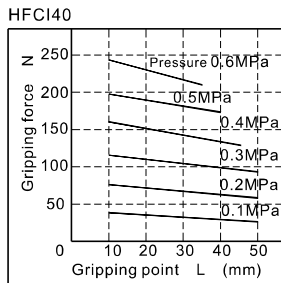
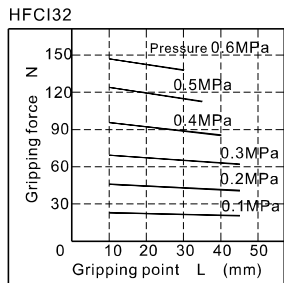
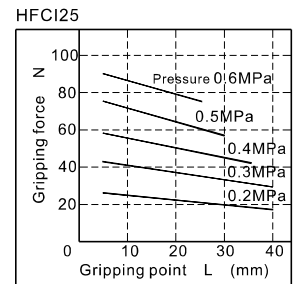
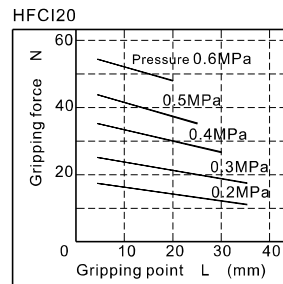
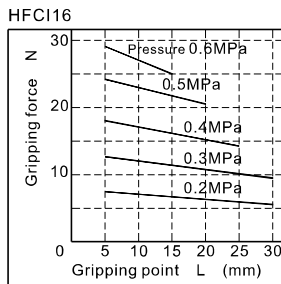
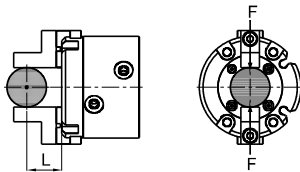

### Opened gripping force(Y Type)

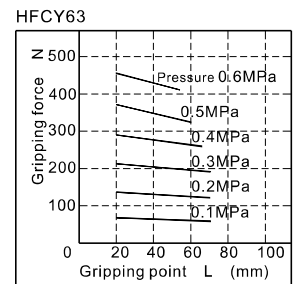
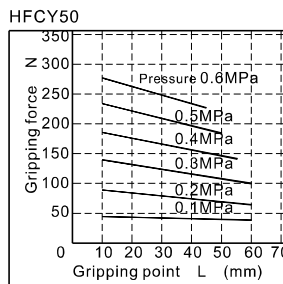
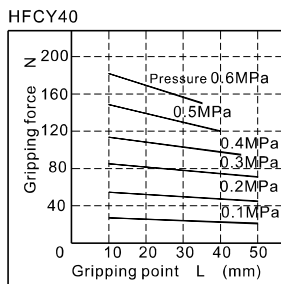
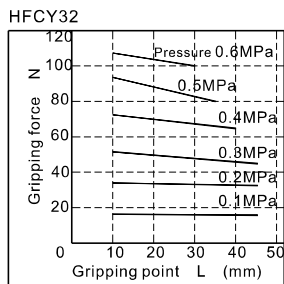
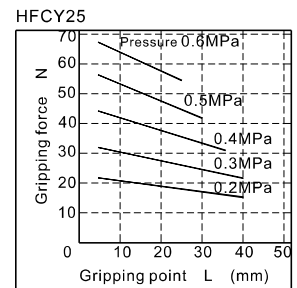
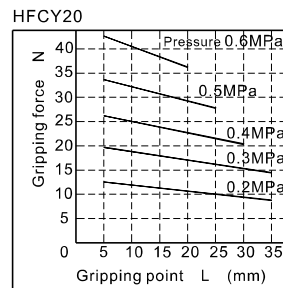
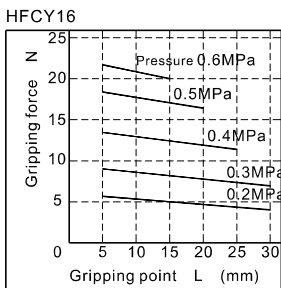
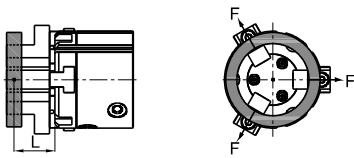

# Air gripper(parallel open/close style)

## HFC Series

### Closed gripping force(Y Type)

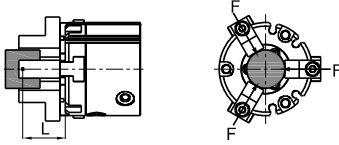

HFCY16

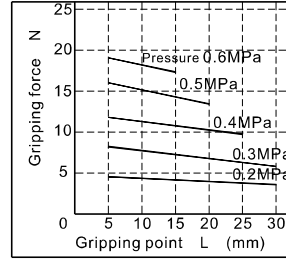

HFCY20

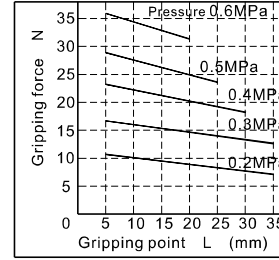

HFCY25

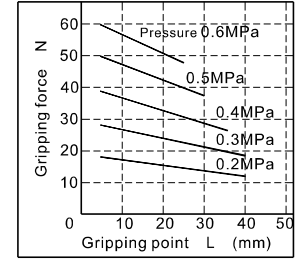

HFCY32

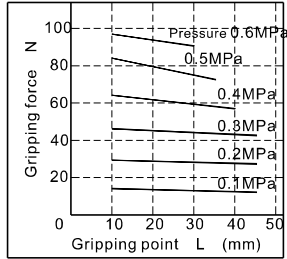

HFCY40

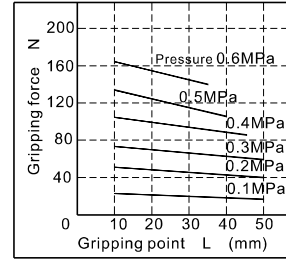

HFCY50

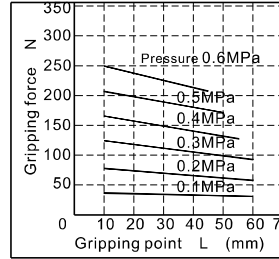

HFCY63

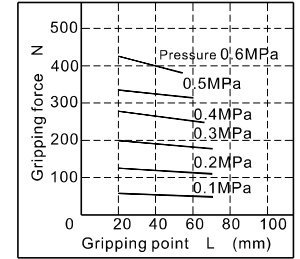

### Opened gripping force(X Type)

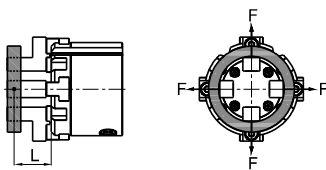

HFCX16

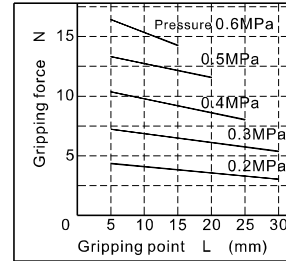

HFCX20

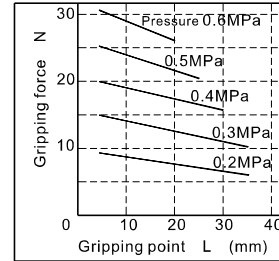

HFCX25

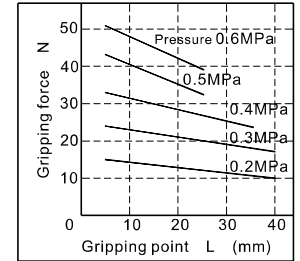

HFCX32

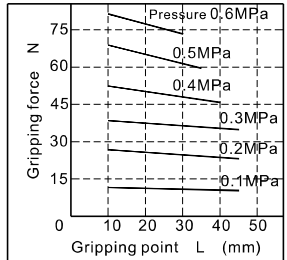

HFCX40

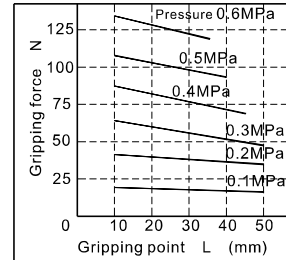

HFCX50

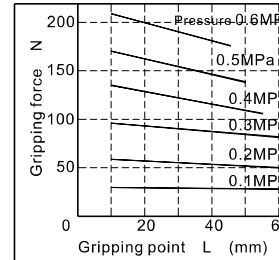

HFCX63

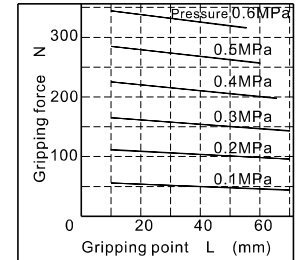

### Closed gripping force(X Type)

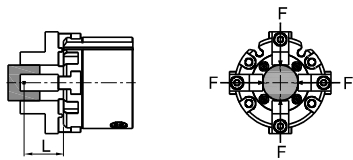

HFCX16

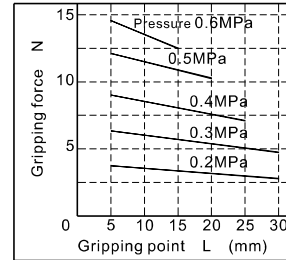

HFCX20

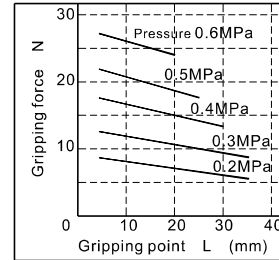

HFCX25

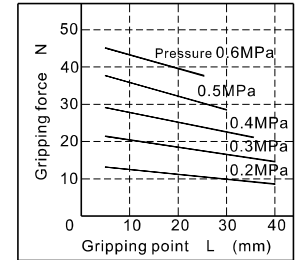

HFCX32

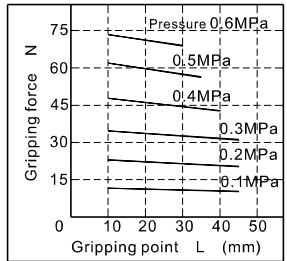

HFCX40

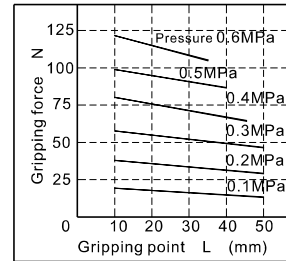

HFCX50

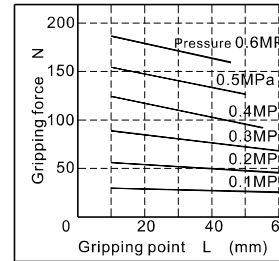

HFCX63

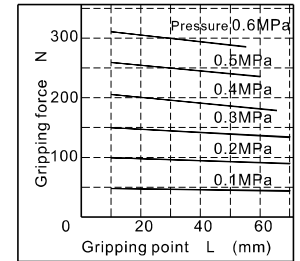



# Air gripper(parallel open/close style)

## HFC Series

### Installation and application

1. Due to the abrupt changes, the circuit pressure is low, which will lead to the decrease of the gripping force and falling of the work-pieces. In order to avoid the harm to the human body and damage to the equipment, anti-dropping device must be equipped.
2. Don't use the air gripper under strong external force and impact force.
3. When install and fix the air gripper, avoid falling down, collision and damage.
4. When fixing the gripping jaw parts, don't twist the gripping jaw.
5. There are several kinds of installation method, and the locking torque of fastening screw must be within the prescribed torque range shown in the below chart. If the locking torque is too large, it will cause the dysfunctional. If the locking torque is too small, it will cause the position deviation and fall.

#### Tail installation type

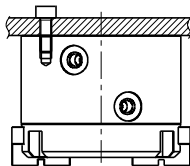

Model	Bore size	The bolts type	Max. locking moment(Nm)	Max. screwed depth(mm)	The aperture of the positioning bore(mm)	The depth of the positioning bore(mm)
HFCI HFCX	16	M4×0.7	2.1	8	Φ17 <sup>+0.05</sup> <sub>0</sub>	1.5
	20	M4×0.7	2.1	8	Φ21 <sup>+0.05</sup> <sub>0</sub>	1.5
	25	M4×0.7	2.1	8	Φ26 <sup>+0.05</sup> <sub>0</sub>	1.5
	32	M5×0.8	4.3	10	Φ34 <sup>+0.05</sup> <sub>0</sub>	2
	40	M6×1.0	7.3	12	Φ42 <sup>+0.05</sup> <sub>0</sub>	2
	50	M6×1.0	7.3	12	Φ52 <sup>+0.05</sup> <sub>0</sub>	2
HFCY	63	M6×1.0	7.3	12	Φ65 <sup>+0.05</sup> <sub>0</sub>	2.5
	16	M3×0.5	0.88	6	Φ17 <sup>+0.05</sup> <sub>0</sub>	1.5
	20	M3×0.5	0.88	6	Φ21 <sup>+0.05</sup> <sub>0</sub>	1.5
	25	M4×0.7	2.1	8	Φ26 <sup>+0.05</sup> <sub>0</sub>	1.5
	32	M4×0.7	2.1	8	Φ34 <sup>+0.05</sup> <sub>0</sub>	2
	40	M5×0.8	4.3	10	Φ42 <sup>+0.05</sup> <sub>0</sub>	2
	50	M5×0.8	4.3	10	Φ52 <sup>+0.05</sup> <sub>0</sub>	2
	63	M6×1.0	7.3	12	Φ65 <sup>+0.05</sup> <sub>0</sub>	2.5

#### The installation of the front through hole

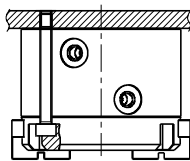

Model	Bore size	The bolts type	Max. locking moment(Nm)
HFCI HFCX	16	M3×0.5	0.88
	20	M3×0.5	0.88
	25	M3×0.5	0.88
	32	M4×0.7	2.1
	40	M5×0.8	4.3
	50	M5×0.8	4.3
HFCY	63	M5×0.8	4.3
	16	M3×0.5	0.88
	20	M3×0.5	0.88
	25	M4×0.7	2.1
	32	M4×0.7	2.1
	40	M5×0.8	4.3
	50	M5×0.8	4.3
	63	M6×1.0	7.3

#### 6. The installation method of the gripping jaw fittings

When install the gripping jaw fittings, you have to pay particular attention that you can only hold the gripping jaw by using spanner, and then lock the screws with allen wrench. Never clamp the body directly and then lock the screws, otherwise the parts will be easily damaged.

#### Install the gripping jaw fittings

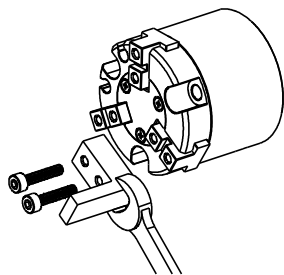

Bore size	The bolts type	Max. locking moment(Nm)
16	M3×0.5	0.59
20	M3×0.5	0.59
25	M3×0.5	0.59
32	M4×0.7	1.4
40	M4×0.7	1.4
50	M5×0.8	2.8
63	M5×0.8	2.8